

PacDrive™ Servo Drive MC-4

The digital Servo Drive MC-4 is characterised by its compact and autonomous structure suitable for wall mounting as well as its leading-edge technology. The innovative MC-4 has the mains supply unit, end stage and software regulator for one axis integrated in a compact casing.

As it communicates with the PacDrive Controller only via fibre optical cable, it is also suitable for a decentralized structure. It requires no user program, comes with single- and multi-turn processing features as standard and configures itself with the help of the electronic name plate in the SM/SH servo motor.

The technical data at a glance:

- World-wide voltage range
- Integrated mains supply unit
- Max. power 34,5 / 69 kVA
- Automatic motor recognition
- Minimum size
- Safety input Inverter Enable
- 250 % overload
- Integrated SERCOS interface



Contents	Product information	1
	Technical Data	3
	Interface	11
	Electrical Connections	13
	Dimensions	19
	Product ID code	25

Imprint © All rights reserved to ELAU AG, also in case of patent right applications.

No part of this documentation and the related software and firm-ware may be reproduced, rewritten, stored on a retrieval system, transmitted or translated into any other language or computer language without the express written consent of ELAU AG.

Every possible measure was taken to ensure that this product documentation is complete and correct. However, since hardware and software are continuously improved, ELAU makes no representations or warranties with respect to the contents of this product documentation.

Trademark PacDrive is a registered trademark of ELAU AG.

All other trademarks mentioned are the exclusive property of their manufacturers.

This Technical Data Sheet does not replace the Operating manual.

For a complete description of the PacDrive MC-4 see the Operating manual PacDrive MC-4

For planning and project activities see the PacDrive Projecting manual

ELAU AG
Dillberg 12
D-97828 Marktheidenfeld
Phone: 09391/606-0
Fax: 09391/606-300
eMail: info@elau.de
Internet: <http://www.elau.de>

Technical Data

**NOTE**

The PacDrive MC-4 supports motors with firmware up to V00.20.XX with a rotary speed up to 6000 min⁻¹.

On firmware versions V00.22.XX, the rated speed is supported up to 12000 min⁻¹.

In case of ambient temperatures >45 °C, for additional exchange of cooling air provide external fan in the switching cabinet.

**NOTE**

The MC-4 is not suitable for fault current protection by means of a commercially available fault circuit-breaker with 30 mA trigger limit.

The device leakage current can trigger the fault circuit-breaker. The following solutions are possible:

Use a default circuit-breaker (RCD, type B) with a trigger limit of 500 mA.

**NOTE**

The PacDrive MC-4 / 1,5 A is adequate only when using firmware versions as from V00.22.XX, in connection with the SH Motor 055.

If a motor is used with a differing power class, the error message „138 invalid motor“ will appear.

Servo drive MC-4 / 1.5A

	Parameter	Value
Product configuration	Product name	MC-4 / 11 / 01 / 400 V
	Order number	13 13 02 44
Power supply	- rated connection voltage	3 AC 380 V (-10%) to 480 V (+10%) - min. 3 AC 380 V (-10%) - max. 3 AC 480 V (+10%)
	- mains frequency	48 ... 62 Hz
	- control voltage/current	DC 24 V (-15% / +25%) / 1 A
DC circuit	- DC-circuit voltage	DC 530 V to 680 V
	- capacity	165 µF
	- U _{Bleeder ON}	DC 820 V
	- U _{Bleeder OFF}	DC 800 V
	- excess voltage	DC 860 V
	- bleeder resistance	120 Ohm
	- bleeder - permanent power	50 W
	- bleeder - peak power	5 kW
Motor connection	- rated power 8 kHz	1.5 Aeff
	- peak current 1 s	3.75 Aeff
	- rated power	1.1 kVA
Stray power	- electronics supply	approx. 12 W
	- bleeder (internal)	0 ... 50 W (depending on the application)
	- power part	approx. 15 W / A
I/Os	Inputs	
	- inputs voltage / current - ie-input - input filter	DC 20 ... 30 V / 5 mA DC 20 ... 30 V / 30 mA [5 ms]
	Outputs	
	- relay outputs	DC 20 ... 30 V / 2 A
Environment	Product size	see chapter Dimensions
	Box size	width: 100 mm height: 400 mm depth: 320 mm
	Product weight	3.1 kg
	Boxed weight	4.0 kg
	Ventilation	natural convection
	Ambient conditions	
	Protection class	
	- casing	IP20
	- installation location	IP54, if the safety wiring is used with Inverter Enable
	- ambient temperature during operation	+5 ... +45 °C (+55 °C with reduced power) -2% per K at I _{NC} and I _{SC})
	- for storage and transport	-25 ... +70 °C
	-insulation	degree of pollution 2 ..., dewing prohibited
	- excess voltage category	K III, T2 (DIN VDE 0110)
	- excess voltage proofness	class 1 (DIN VDE 0160)
	- degree of radio distortion	class A EN 55011 / EN 61800 - 3
	rel. humidity	5% - 85% climatic category 3K3 EN 60 721
Approval	Approvals	CE, UL, cUL

Table 2-1: Technical data of the MC-4 Servo drive / 01

Servo drive MC-4 / 3 A

Parameter	Value
Product name	MC-4 / 11 / 03 / 400 V
Order number	13 13 02 45
- rated connection voltage	3 AC 380 V (-10%) to 480 V (+10%)
- mains frequency	- min. 3 AC 380 V (-10%) - max. 3 AC 480 V (+10%)
- control voltage/current	48 ... 62 Hz DC 24 V (-15% / +25%) / 1 A
- DC-circuit voltage	DC 530 V to 680 V
- capacity	165 μ F
- U _{Bleeder ON}	DC 820 V
- U _{Bleeder OFF}	DC 800 V
- excess voltage	DC 860 V
- bleeder resistance	120 Ohm
- bleeder - permanent power	50 W
- bleeder - peak power	5 kW
- rated power 8 kHz	3 A _{eff}
- peak current 1 s	7.5 A _{eff}
- rated power	2.1 kVA
- electronics supply	approx. 12 W
- bleeder (internal)	0 ... 50 W (depending on the application)
- power part	approx. 15 W / A
Inputs	
- inputs voltage / current	DC 20 ... 30 V / 5 mA
- ie-input	DC 20 ... 30 V / 30 mA
- input filter	[5 ms
Outputs	
- relay outputs	DC 20 ... 30 V / 2 A
Product size	see chapter Dimensions
Box size	width: 100 mm height: 400 mm depth: 320 mm
Product weight	3.1 kg
Boxed weight	4.0 kg
Ventilation	natural convection
Ambient conditions	
Protection class	
- casing	IP20
- installation location	IP54, if the safety wiring is used with Inverter Enable
- ambient temperature during operation	+5 ... +45 °C (+55 °C with reduced power)
- for storage and transport	-2% per K at I _{NC} and I _{SC})
- insulation	-25 ... +70 °C degree of pollution 2 ..., dewing prohibited
- excess voltage category	K III, T2 (DIN VDE 0110)
- excess voltage proofness	class 1 (DIN VDE 0160)
- degree of radio distortion	class A EN 55011 / EN 61800 - 3
rel. humidity	5% - 85% climatic category 3K3 EN 60 721
Approvals	CE, UL, cUL

Table 2-2: Technical data of the MC-4 Servo drive / 03

Servo drive MC-4 / 5 A



CAUTION!

Unit has different rated connection voltage!
 Wrong connection voltage may destroy the Servo drive!
 During wiring and installation, make sure that the connection voltage matches the Servo drive.

	Parameter	Value
Product configuration	product name	MC-4 / 11 / 05 / 230 V
	order number	13 13 02 46
Power supply	- rated connection voltage	3 AC / 1 AC 220 V (-10%) to 240 V (+ 10%)
	- mains frequency	48 ... 62 Hz
	- control voltage/power	DC 24 V (-15% / +25%) / 1 A
DC circuit	- DC-circuit voltage	DC 260 V to 370 V
	- capacity	660 µF
	- U _{Bleeder ON}	DC 410 V
	- U _{Bleeder OFF}	DC 400 V
	- excess voltage	DC 430 V
	- bleeder resistance	33 Ohm
	- bleeder - permanent power	50 W
	- bleeder - peak power	5 kW
Motor connection	- rated power 8 kHz	5 Aeff
	- peak current 1 s	12.5 Aeff
	- rated power	1.9 kVA
Stray power	- electronics supply	approx. 12 W
	- bleeder (internal)	0 ... 50 W (depending on the application)
	- power part	approx. 15 W / A
I/Os	- input voltage/current	DC 20 ... 30 V / 5 mA
	- ie-input	DC 20 ... 30 V / 30 mA
	- input filter	≤5 ms
	- relay outputs	DC 20 ... 30 V / 2 A
Environment	Product size	see chapter Dimensions
	Box size	width: 100 mm height: 320 mm depth: 400 mm
	Product weight	3.1 kg
	Boxed weight	4.0 kg
	ventilation	natural convection
	ambient conditions	
	Protection class	
	- casing	IP20
- installation location	IP54, if the safety wiring is used with Inverter Enable	
- ambient temperature during operation	+5 ... +45 °C (+55 °C with reduced power -2% per K at I _{NC} and I _{SC})	
- for storage and transport	-25 ... +70 °C	
-insulation	degree of pollution 2 ..., dewing prohibited	
- excess voltage category	K III, T2 (DIN VDE 0110)	
- excess voltage proofness	class 1 (DIN VDE 0160)	
- degree of radio distortion	class A EN 55011 / EN 61800 - 3	
rel. humidity	5% - 85% climatic category 3K3 EN 60 721	
Approval	Approvals	CE, UL, cUL

Table 2-3: Technical data of the MC-4 Servo drive / 05

Servo drive MC-4 / 10 A

	Parameter	Value
Product configuration	product name	MC-4 / 11 / 10 / 400 V
	order number	13 13 02 47
Power supply	- rated connection voltage	3 AC 380 V (-10%) to 480 V (+ 10%)
	- mains frequency	48 ... 62 Hz
DC circuit	- control voltage/power	DC 24 V (-15% / +25%) / 1 A
	- DC-circuit voltage	DC 530 V to 680 V
	- capacity	330 µF
	- U _{Bleeder} ON	DC 820 V
	- U _{Bleeder} OFF	DC 800 V
	- excess voltage	DC 860 V
	- bleeder resistance	60 Ohm
	- bleeder - permanent power	100 W
Motor connection	- bleeder - peak power	10 kW
	- rated power 8 kHz	10 Aeff
Stray power	- peak current 1 s	25 Aeff
	- rated power	6.9 kVA
I/Os	- electronics supply	approx. 12 W
	- bleeder (internal)	0 ... 100 W (depending on the application)
	- power part	approx. 15 W / A
Environment	- input voltage/current	DC 20 ... 30 V / 5 mA
	- ie-input	DC 20 ... 30 V / 30 mA
Approval	- input filter	≤5 ms
	- relay outputs	DC 20 ... 30 V / 2 A
	Product size	see chapter Dimensions
	Box size	width: 100 mm height: 320 mm depth: 400 mm
	Product weight	3.1 kg
	Boxed weight	4.5 kg
	ventilation	internal fan (temperature closed-loop controlled)
	ambient conditions	
Protection class	IP20	
- casing	IP54, if the safety wiring is used with Inverter Enable	
- installation location		
- ambient temperature during operation	+5 ... +45 °C (+55 °C with reduced power	
- for storage and transport	-2% per K at I _{NC} and I _{SC})	
- insulation	-25 ... +70 °C	
- excess voltage category	degree of pollution 2 ..., dewing prohibited	
- excess voltage proofness	K III, T2 (DIN VDE 0110)	
- degree of radio distortion	class1 (DIN VDE 0160)	
rel. humidity	class A EN 55011 / EN 61800 - 3	
Approvals	5% - 85% climatic category 3K3 EN 60 721	
Approvals	CE, UL, cUL	

Table 2-4: Technical data of the MC-4 Servo drive / 10

Servo drive MC-4 / 22 A

	Parameter	Value
Product configuration	product name	MC-4 / 11 / 22 / 400 V
	order number	13 13 02 54
Power supply	- rated connection voltage	3 AC 380 V (-10%) to 480 V (+ 10%)
	- mains frequency	48 ... 62 Hz
	- control voltage/power	DC 24 V (-15% / +25%) / 1 A
DC circuit	- DC-circuit voltage	DC 530 V to 680 V
	- capacity	705 µF
	- U _{Bleeder ON}	DC 820 V
	- U _{Bleeder OFF}	DC 800 V
	- excess voltage	DC 860 V
	- bleeder resistance	42 Ohm
	- bleeder - permanent power	150 W
	- bleeder - peak power	15 kW
Motor connection	- rated power 8 kHz	22 Aeff
	- peak current 1 s	55 Aeff
	- rated power	15.2 kVA
Stray power	- electronics supply	approx. 12 W
	- bleeder (internal)	0 ... 150 W (depending on the application)
	- power part	approx. 15 W / A
I/Os	- input voltage/current	DC 20 ... 30 V / 5 mA
	- ie-input - input filter	DC 20 ... 30 V / 30 mA ≤5 ms
	- relay outputs	DC 20 ... 30 V / 2 A
Environment	Product size Box size	see chapter Dimensions width: 160 mm height: 310 mm depth: 400 mm
	Product weight Boxed weight	6.3 kg 7.0 kg
	ventilation	internal fan (temperature closed-loop controlled)
	ambient conditions Protection class - casing - installation location - ambient temperature during operation - for storage and transport -insulation	IP20 IP54, if the safety wiring is used with Inverter Enable +5 ... +45 °C (+55 °C with reduced power - 2% per K at I _{NC} and I _{SC}) -25 ... +70 °C degree of pollution 2 ..., dewing prohibited
	- excess voltage category - excess voltage proofness - degree of radio distortion rel. humidity	K III, T2 (DIN VDE 0110) class 1 (DIN VDE 0160) class A EN 55011 / EN 61800 - 3 5% - 85% climatic category 3K3 EN 60 721
Approval	Approvals	UL , cUL

Table 2-5: Technical data of the MC-4 Servo drive / 22

Servo drive MC-4 / 50 A

	Parameter	Value
Product configuration	product name	MC-4 / 11 / 50 / 400 V
	order number	13 13 02 56
Power supply	- rated connection voltage - mains frequency - control voltage/power	3 AC 380 V (-10%) to 480 V (+ 10%) 48 ... 62 Hz DC 24 V (-15% / +25%) / max. 3 A
DC circuit	- DC-circuit voltage - capacity - U _{Bleeder ON} - U _{Bleeder OFF} - excess voltage - bleeder resistance - bleeder - permanent power - bleeder - peak power	DC 530 V to 680 V 1400 µF DC 820 V DC 800 V DC 860 V 18 Ohm approx. 600 W at an ambient temperature of 45 °C 35 kW
Motor connection	- rated power 8 kHz - peak current 1 s - rated power	50 Aeff 125 Aeff 34.6 kVA
Stray power	- electronics supply - bleeder (internal) - power part	approx. 55 W 0 ... 600 W (depending on the application) approx. 15 W / A
I/Os	- input voltage/current - ie-input - input filter	DC 20 ... 30 V / 5 mA DC 20 ... 30 V / 30 mA ≤5 ms
	- relay outputs	DC 20 ... 30 V / 2 A
Environment	Product size Box size	see chapter Dimensions width: 100 mm height: 320 mm depth: 400 mm
	Product weight Boxed weight	16.5 kg 19.5 kg
	ventilation	internal fan (temp. closed-loop controlled)
	ambient conditions Protection class - casing - installation location - ambient temperature during operation - for storage and transport - insulation - excess voltage category - excess voltage proofness - degree of radio distortion rel. humidity	IP20 IP54, if the safety wiring is used with Inverter Enable +5 ... +45 °C (+55 °C with reduced power - 2% per K at I _{NC} and I _{SC}) -25 ... +70 °C degree of pollution 2 ..., dewing prohibited K III, T2 (DIN VDE 0110) class 1 (DIN VDE 0160) class A EN 55011 / EN 61800 - 3 with external mains filter 5% - 85% climatic category 3K3 EN 60 721
Approval	Approvals	CE, UL, cUL (in preparation)

Table 2-6: Technical data of the MC-4 Servo drive / 50



CAUTION!

Condition for running the PacDrive MC-4 / 50A is a firmware version V00.11.XX or higher!

Some functions (also safety-related functions) are not supported in firmware versions smaller than V00.11.XX!

- Only use the PacDrive MC-4 / 50A with the firmware in delivery condition (original condition)
 - If an exchange of the firmware is indispensable, exclusively use versions higher than V00.11.XX
-



NOTE

The „ambient temperature during operation“ up to 45 °C is only valid if the control voltage is at least DC 24 V, so that the fans can work with the required power.



NOTE

To observe EMT requirements, it is necessary to use an external mains filter (order number FI07878).

Interface

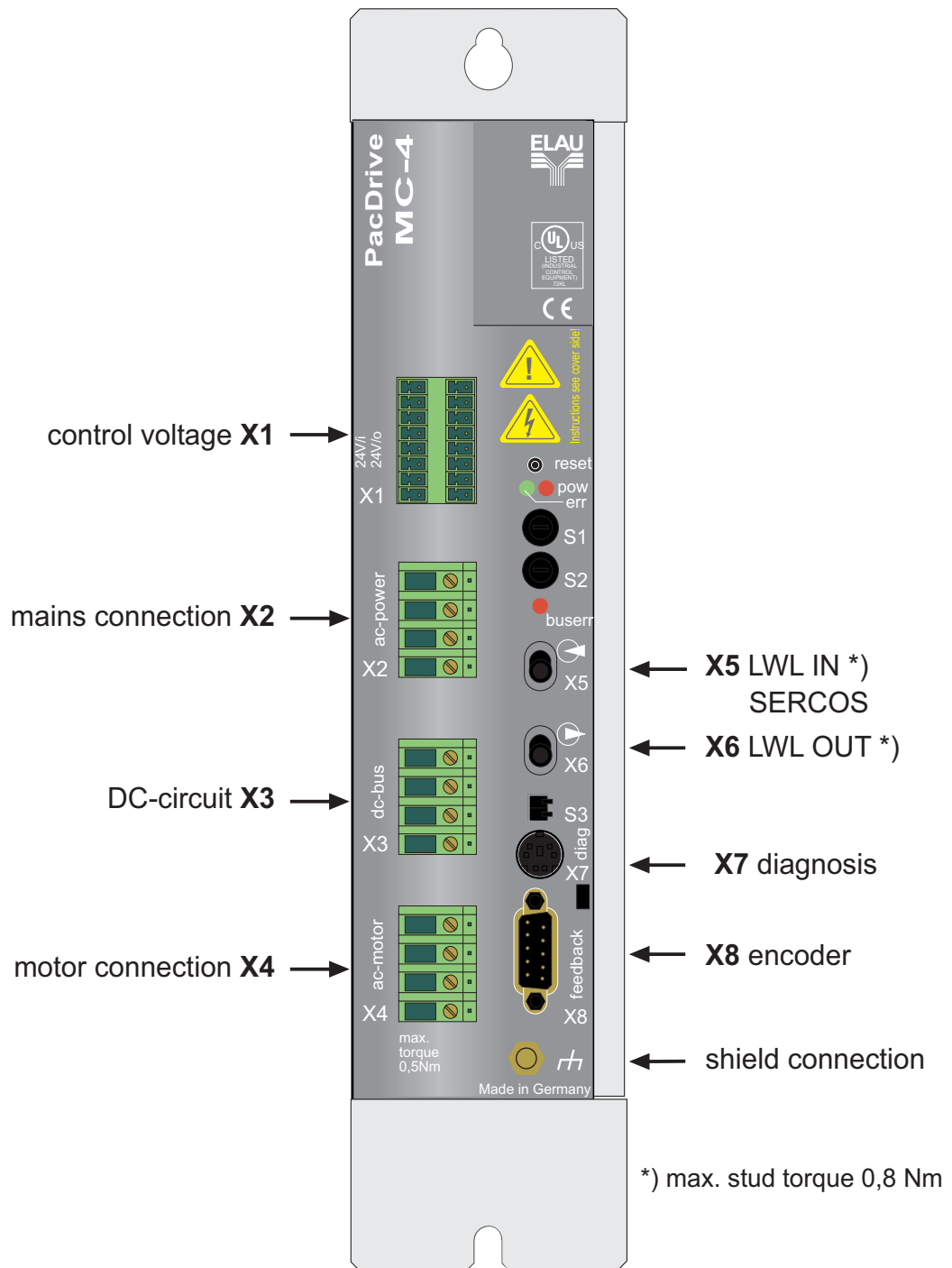

PDM_Anschlussübersicht_MC-4_us9912.FH8

Fig. 3-1: Overview of connections of the MC-4 Servo drive

Electrical Connections

X1 - control voltage(MC-4 1.5 A to 10 A)

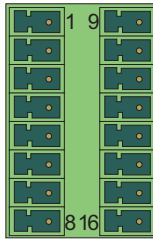

Pin	Designation	Meaning	Range	Max. cross section
1	24 V	supply voltage	-15% / +25%	1.5 mm ²
2	0 V	supply voltage		1.5 mm ²
3	iei	inverter enable		1.5 mm ²
4	en	enable	DC 24V (acc. IEC61131-2 Typ I)	1.5 mm ²
5	ϑ (5)	PTC motor temp.		1.5 mm ²
6	ϑ (6)	PTC motor temp.		1.5 mm ²
7	bi+	power supply holding brake	DC +24V	1.5 mm ²
8	bi-	power supply holding brake	DC 0V	1.5 mm ²
9	24 V	bridged with Pin 1		1.5 mm ²
10	0 V	bridged with Pin 2		1.5 mm ²
11	ieo	inverter enable output		1.5 mm ²
12	ieo	inverter enable output		1.5 mm ²
13	rdy	ready contact (opens in case of error)	DC 20...30V / 2A	1.5 mm ²
14	rdy	ready contact	DC 20...30V / 2A	1.5 mm ²
15	bo+ (8)	connection holding brake	DC +24V	1.5 mm ²
16	bo- (7)	connection holding brake	0V	1.5 mm ²

Table 3-1: Electrical connections of the MC-4 (1.5 ... 10 A) / X1

NOTE

The permitted continuous current of the plug-in terminal „X1-control voltage (MC-4 1.5 A to 10 A)“ amounts to 8 A. The maximum number of parallel over plug-in terminal X1 connected MC's may not exceed the number of six units.

X2 - mains connection (MC-4 1.5 A to 10 A)

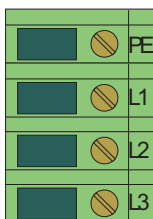

Pin	Designation	Meaning	Range	Max. cross section
1	PE	earth conductor connection		2.5 mm ²
2	L1	phase L1	3 AC 380 - 480 V	2.5 mm ²
3	L2	phase L2	3 AC 380 - 480 V	2.5 mm ²
4	L3	phase L3	3 AC 380 - 480 V	2.5 mm ²

Table 3-2: Electrical connections of the MC-4 (1.5 ... 10 A) / X2



NOTE

The permitted continuous current of the power clamp “X2-mains connection (MC-4 1.5 A to 10 A)” amounts to 24 A.



NOTE

The range for the MC-4 / 5 A is 220 - 240 V with 3-phase or 1-phase feed. With 1-phase feed, connect L to L1 and N to L2. Leave L3 free.



CAUTION!

No safe contact!

Cables and clamps may be damaged!

- For cables with a cross section of 2.5 mm², use end sleeves without plastic collar and a length of at least 12 mm or end sleeves with plastic collar and a metal sleeve that is at least 12 mm long.

X3 - DC-circuit (MC-4 1.5 A to 10 A)

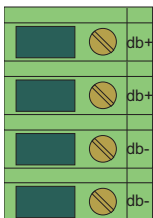

Pin	Designation	Meaning	Range	Max. cross section
1	db +	DC-circuit voltage +	DC 0 - 860 V	2.5 mm ²
2	db +	DC-circuit voltage +	DC 0 - 860 V	2.5 mm ²
3	db -	DC-circuit voltage -	DC 0 - 860 V	2.5 mm ²
4	db -	DC-circuit voltage -	DC 0 - 860 V	2.5 mm ²

Table 3-3: Electrical connections of the MC-4 (1.5 ... 10 A) / X3



NOTE

The permitted continuous current of the power clamp “X3-DC-circuit (MC-4 1.5 A to 10 A)” amounts to 24 A.



CAUTION!

No safe contact!

Cables and clamps may be damaged!

- For cables with a cross section of 2.5 mm², use end sleeves without plastic collar and a length of at least 12 mm or end sleeves with plastic collar and a metal sleeve that is at least 12 mm long.

X4 - motor connection (MC-4 1.5 A to 10 A)

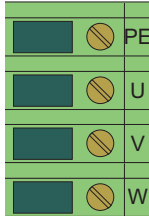

Pin	Designation	Meaning	Range	Max. cross section
1	PE	earth conductor connection		2.5 mm ²
2	U	phase U	3 AC 0 - 480 V	2.5 mm ²
3	V	phase V	3 AC 0 - 480 V	2.5 mm ²
4	W	phase W	3 AC 0 - 480 V	2.5 mm ²

Table 3-4: Electrical connections of the MC-4 (1.5 ... 10 A) / X4



NOTE

The permitted continuous current of the power clamp “X4-motor connection (MC-4 1.5 A to 10 A)” amounts to 24 A.



CAUTION!

No safe contact!

Cables and clamps may be damaged!

- For cables with a cross section of 2.5 mm², use end sleeves without plastic collar and a length of at least 12 mm or end sleeves with plastic collar and a metal sleeve that is at least 12 mm long.

X1 - control voltage (MC-4 22 A, 50 A)

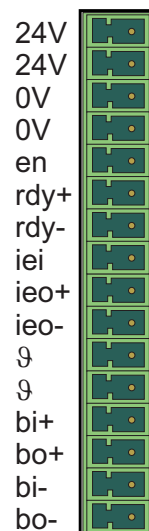

Pin	Designation	Meaning	Range	Max. cross section
1	24 V	supply voltage	-15% / +25%	1.5 mm ²
2	24 V	bridged with pin 1		1.5 mm ²
3	0 V	supply voltage		1.5 mm ²
4	0 V	bridged with Pin 3		1.5 mm ²
5	en	enable	DC 24V (acc. IEC61131-2 Typ I)	1.5 mm ²
6	rdy+	ready contact	DC 20...30V / 2A	1.5 mm ²
7	rdy-	ready contact (opens in case of error)	DC 20...30V / 2A	1.5 mm ²
8	iei	inverter enable		1.5 mm ²
9	ieo+	inverter enable output		1.5 mm ²
10	ieo-	inverter enable output		1.5 mm ²
11	(5)	PTC motor temp.		1.5 mm ²
12	(6)	PTC motor temp.		1.5 mm ²
13	bi+	power supply holding brake	DC +24V	1.5 mm ²
14	bo+ (8)	connection holding brake	DC +24V	1.5 mm ²
15	bi-	power supply holding brake	DC 0V	1.5 mm ²
16	bo- (7)	connection holding brake	0V	1.5 mm ²

Table 3-5: Electrical connections of the MC-4 (22 A, 50 A) / X1

X2 - mains connection (MC-4 22 A)

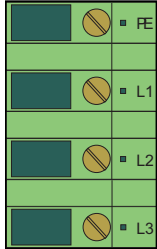

Pin	Designation	Meaning	Range	Max. cross section
1	PE	earth conductor connection		4 mm ²
2	L1	phase L1	3 AC 380 - 480V	4 mm ²
3	L2	phase L2	3 AC 380 - 480V	4 mm ²
4	L3	phase L3	3 AC 380 - 480V	4 mm ²

Table 3-6: Electrical connections of the MC-4 (22 A) / X2

X3 - DC-circuit (MC-4 22 A)

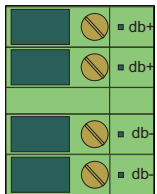

Pin	Designation	Meaning	Range	Max. cross section
1	db +	DC-circuit voltage +	DC 0 - 860 V	4 mm ²
2	db +	DC-circuit voltage +	DC 0 - 860 V	4 mm ²
3	db -	DC-circuit voltage -	DC 0 - 860 V	4 mm ²
4	db -	DC-circuit voltage -	DC 0 - 860 V	4 mm ²

Table 3-7: Electrical connections of the MC-4 (22 A) / X3

X4 - motor connection (MC-4 22 A)

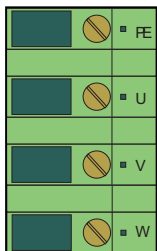

Pin	Designation	Meaning	Range	Max. cross section
1	PE	earth conductor connection		4 mm ²
2	U (1)	phase U	3 AC 0 - 480V	4 mm ²
3	V (2)	phase V	3 AC 0 - 480V	4 mm ²
4	W (3)	phase W	3 AC 0 - 480V	4 mm ²

Table 3-8: Electrical connections of the MC-4 (22 A) / X4

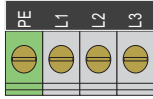
X2 - mains connection (MC-4 50 A)

Pin	Designation	Meaning	Range	Max. cross section
1	PE	earth conductor connection		16 mm ²
2	L1	phase L1	3 AC 380 - 480V	16 mm ²
3	L2	phase L2	3 AC 380 - 480V	16 mm ²
4	L3	phase L3	3 AC 380 - 480V	16 mm ²

Table 3-9: Electrical connections of the MC-4 (50 A) / X2

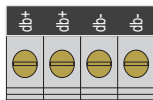
X3 - DC-circuit (MC-4 50 A)

Pin	Designation	Meaning	Range	Max. cross section
1	db +	DC-circuit voltage +	DC 0 - 860 V	16 mm ²
2	db +	DC-circuit voltage +	DC 0 - 860 V	16 mm ²
3	db -	DC-circuit voltage -	DC 0 - 860 V	16 mm ²
4	db -	DC-circuit voltage -	DC 0 - 860 V	16 mm ²

Table 3-10: Electrical connections of the MC-4 (50 A) / X3

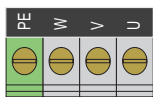
X4 - motor connection (MC-4 50 A)

Pin	Designation	Meaning	Range	Max. cross section
1	PE	earth conductor connection		16 mm ²
2	W (3)	phase W	3 AC 0 - 480V	16 mm ²
3	V (2)	phase V	3 AC 0 - 480V	16 mm ²
4	U (1)	phase U	3 AC 0 - 480V	16 mm ²

Table 3-11: Electrical connections of the MC-4 (50 A) / X4

**NOTE**

The X4 pin assignment of the PacDrive MC-4 / 50 A distinguish from all other PacDrive MC-4. Pay attention to the connector labeling.

X7 - diagnosis



Pin	Designation	Meaning	Range	Max. cross section
1	PRO_SEL			0.25 mm ²
2	RxD	Receive Data		0.25 mm ²
3	TxD	Transmit Data		0.25 mm ²
4	GND	Signal Ground		0.25 mm ²
5	RS232_SEL			0.25 mm ²
6	VCC			0.25 mm ²

Table 3-12: Electrical connections of the MC-4 / X7

X8 - motor encoder (SinCos)

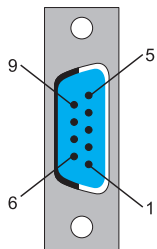

Pin	Designation	Meaning	Range	Max. cross section
1	REFSIN	sinus reference signal		0.25 mm ²
2	SIN	sinus trace		0.25 mm ²
3	REFCOS	cosine reference signal		0.25 mm ²
4	COS	cosine trace		0.25 mm ²
5	+12V	supply voltage		0.25 mm ²
6	RS485	parameter channel -		0.25 mm ²
7	RS485	parameter channel +		0.25 mm ²
8	SC_SEL	encoder connected (bridge to GND)		0.25 mm ²
9	GND	supply voltage		0.25 mm ²

Table 3-13: Electrical connections of the MC-4 / X8



CAUTION!

Disconnection of SinCos encoder plug while unit is powered on! SinCos encoder may be damaged!

- Disconnect and connect the SinCos encoder plug only in voltage-free state (disconnect MC-4 Servo drive from 24 V power supply!).

Dimensions

Servo drive MC-4 / 1.5 A and 3 A

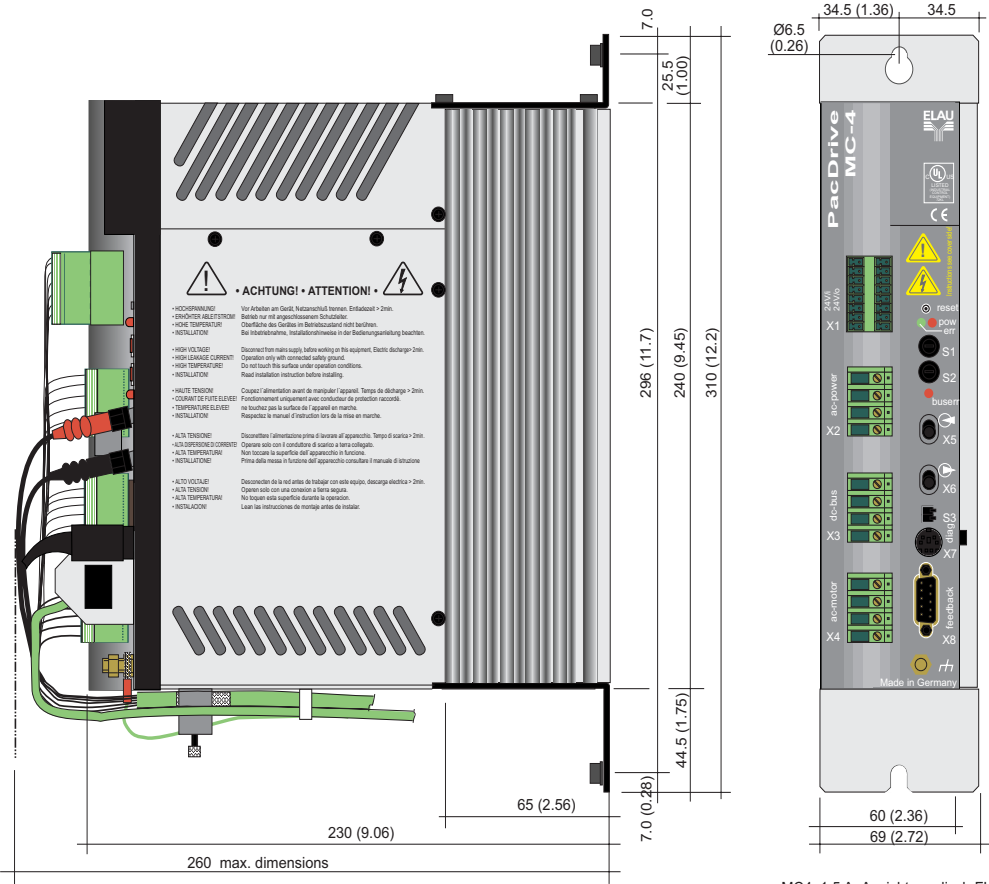

MC4_1.5 A_Ansicht_english.FH8

Fig. 4-1: Dimensions of the MC-4 / 1.5 A and 3 A

Servo drive MC-4 / 5 A (230 V)

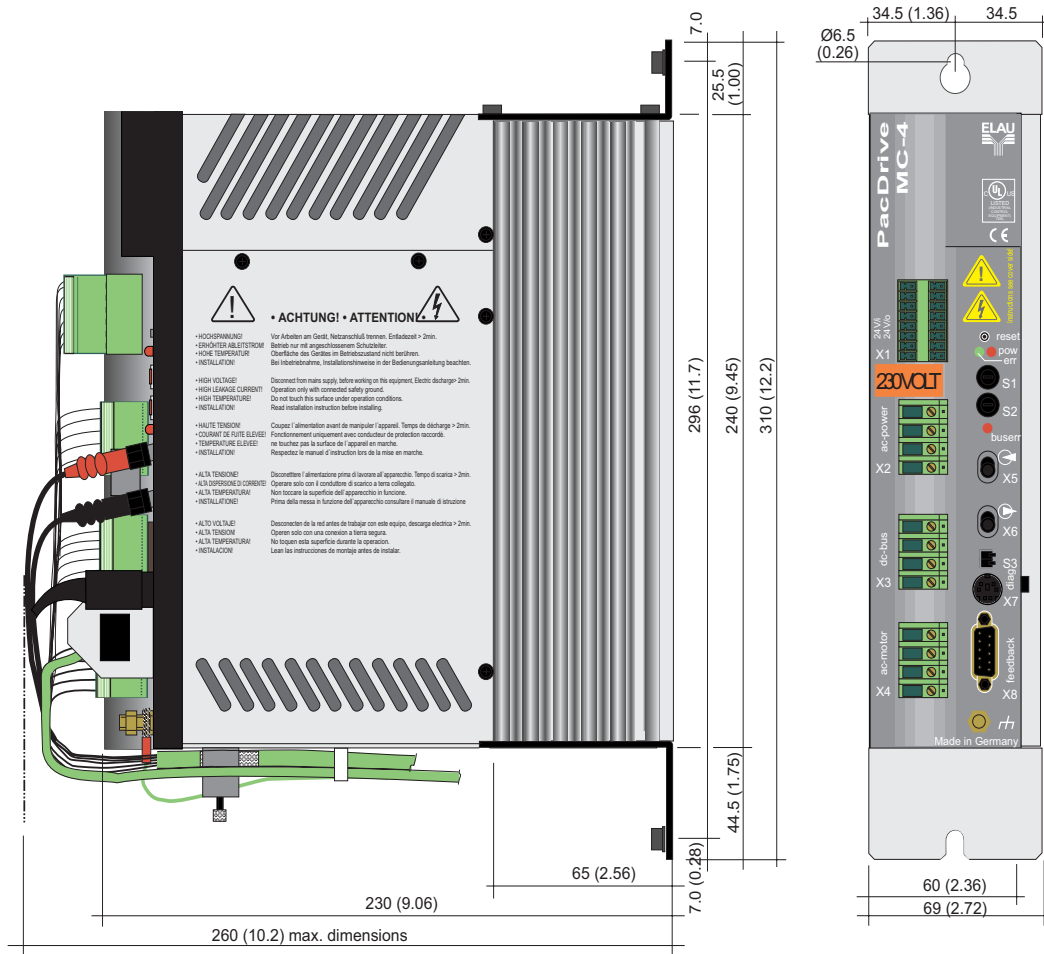

MC4_5A_Ansicht_englisch.FH8

Fig. 4-2: Dimensions of the MC-4 / 5 A

Servo drive / 10 A

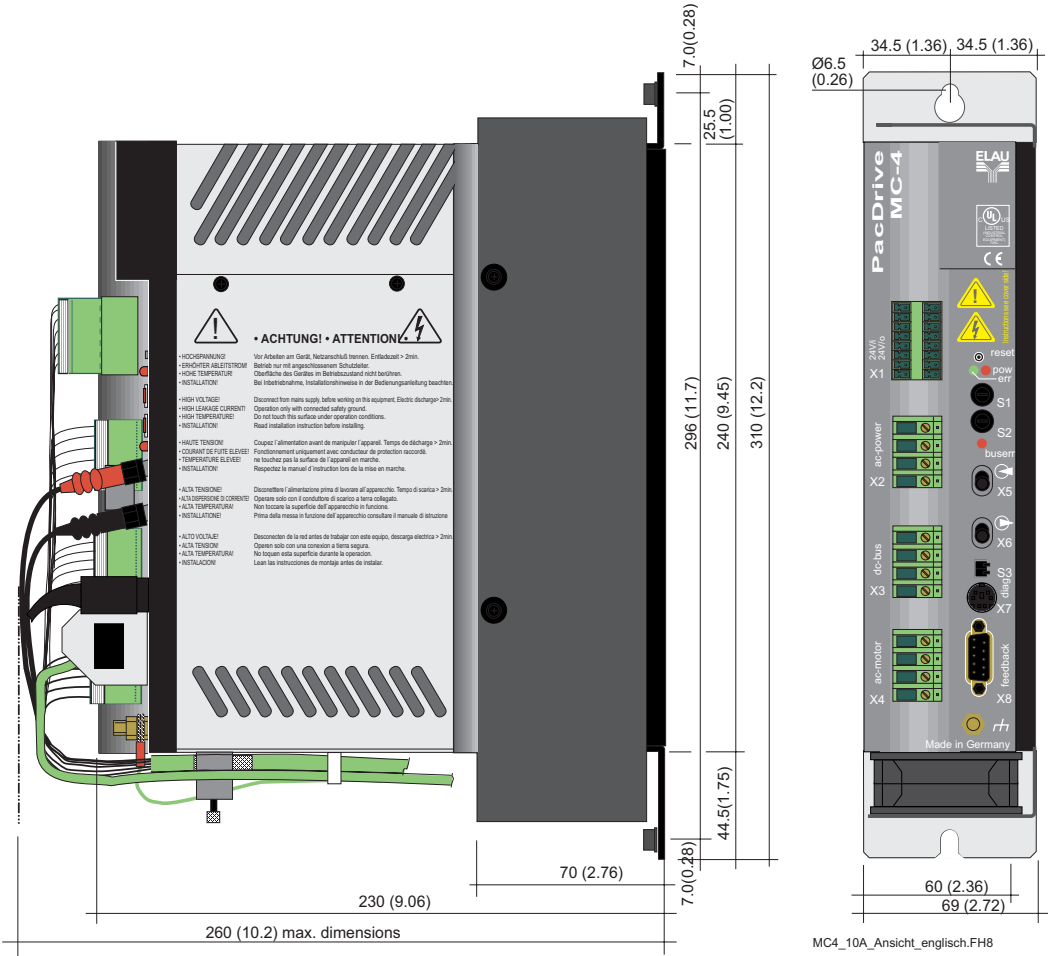

MC4_10A_Ansicht_englisch.FH8

Fig. 4-3: Dimensions of the MC-4 / 10 A

Servo drive MC-4 / 22 A

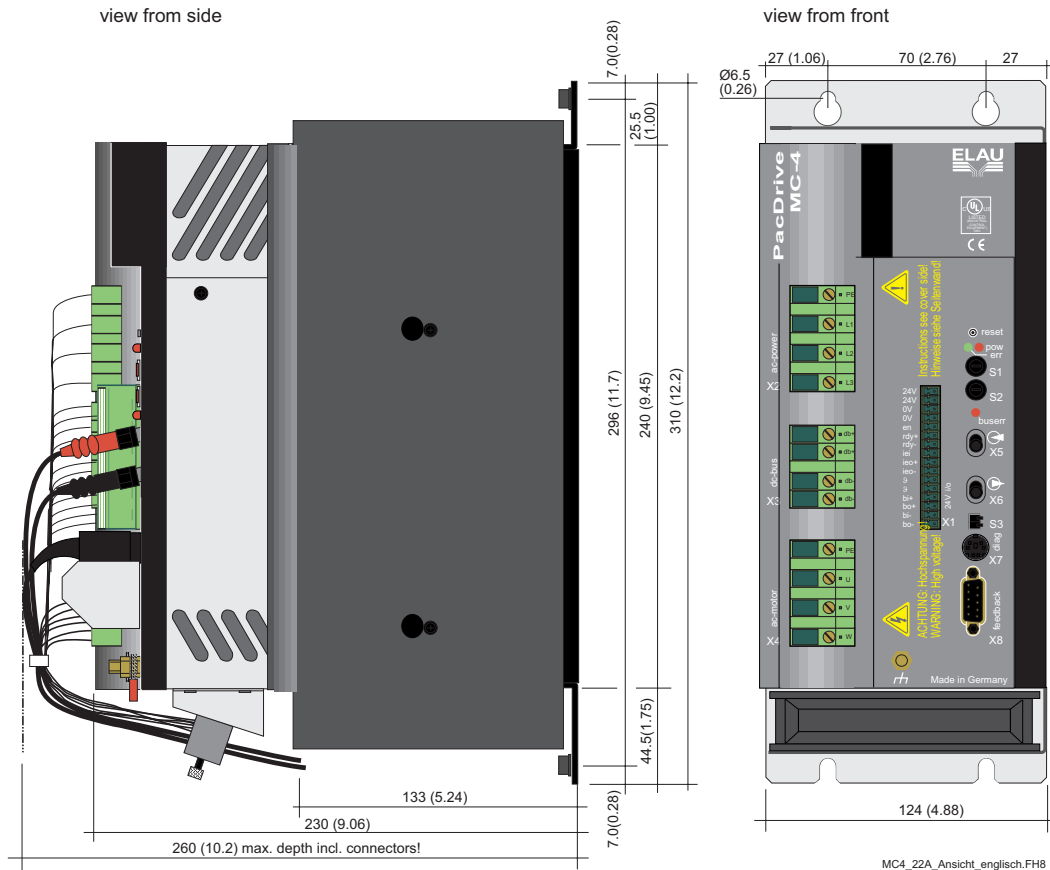

Fig. 4-4: Dimensions of the MC-4 / 22 A

Product ID Code

Type key

MC-4 / 11 / 10 / 400

Variant
11

Rated current
e.g. 03 = 3 A

Rated voltage
230 = 230 V
400 = 400 V (3 external ducts)

